

Movement by Perfection

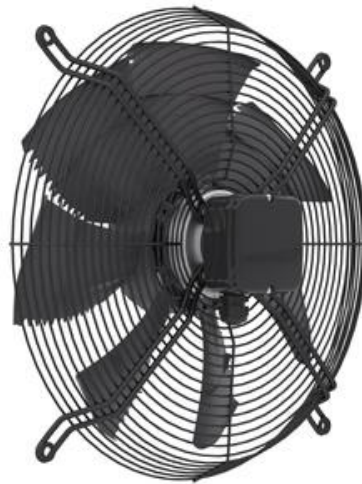

The Royal League in ventilation, control and drive technology



[Product documentation](#)

Type
FN040-4EW.0F.A7P1

Article number
154201

Product documentation

Customer

ZIEHL-ABEGG Contact

Rita Sang

Tel.

rita.sang@ziehl-abegg.com.cn

Project

ZIEHL-ABEGG Subsidiary

China

ZIEHL-ABEGG Mechanical
and Electrical Equipment (Shanghai)
Co. Ltd.

No. 65 Hong Mu Dan Road

Xinbang Town

Songjiang District

SHANGHAI 201605

CHINA

Phone +86 21 57893991

Fax +86 21 57893932

www.ziehl-abegg.cn

info@ziehl-abegg.com.cn

Type

FN040-4EW.0F.A7P1

Article number

154201

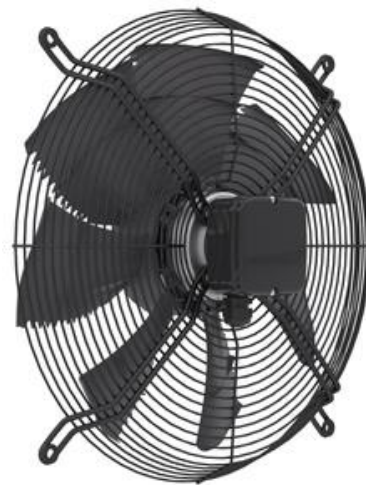

Contents

1.	Product specification - Technical data	3
2.	Characteristic Curve	4
3.	Drawing	6
4.	Connection diagram	7
5.	EU-Declaration of conformity	8

1. Product specification - Technical data

Article number	154201
Type	FN040-4EW.0F.A7P1
Designation	Axial fan with sickle blades
Rated values	1~230V±10% 50Hz P ₁ 240W 1.05A ΔI=15% 1340/min 5.0uF/400V 65°C 1~230V±10% 60Hz P ₁ 330W 1,45A ΔI=5% 1480/min 5,0uF/400V PsF max. 70Pa 40°C
Electrical connection	Terminal box K05
Min. operating temperature °C	-25***
Mounting type terminal box	Mounted on Stator
Type of protection	IP54
Thermal class	THCL155
Connection diagram	1360-104XB
Rating plate	1x fixed
Fitting position	H/Vu/Vo
Motor protection	thermal contact
Impregnation	Moisture and hot climate protection
Quality of bearings	ball bearing with long-time lubrication
Material Rotor	Aluminium
Painting rotor	Rotor 1 coat painted
colour rotor	RAL 9005 (jet black)
Material blades	High Performance Composite Material
Painting impeller	unpainted
Colour blades	black
Guard grille type	ring grill
Control	--
Painting mot.suspens	Motor suspension powder-coated consistency class 2
colour suspension	RAL 9005 (jet black)
Weight kg	5,50
ErP Data	Efficiency η_{statA} : 31,1 % Efficiency grade: $N_{actual} = 41,3 / N_{target} = 40^*$ *ErP 2015

2. Characteristic Curve

FN040-4EW.0F.A7P1

Measured with full nozzle without guard grille in installation type A according to ISO 5801

1~ 230V 50Hz

Messdichte 1,16

Air performance

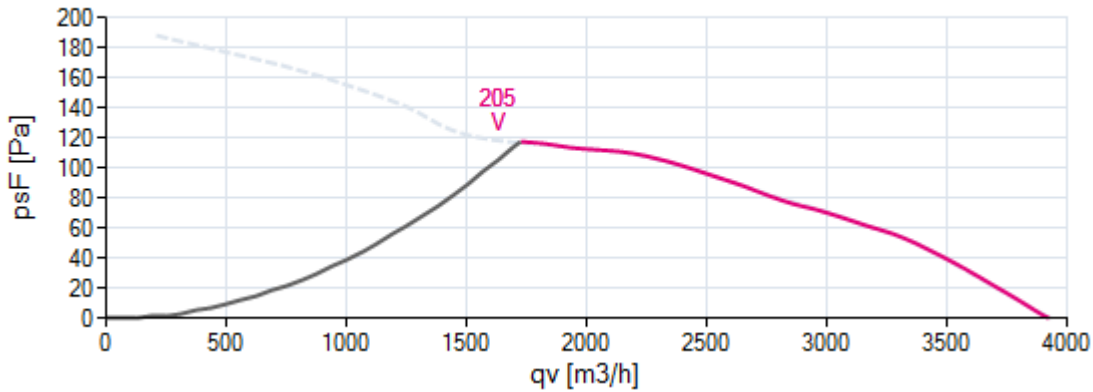

Acoustics

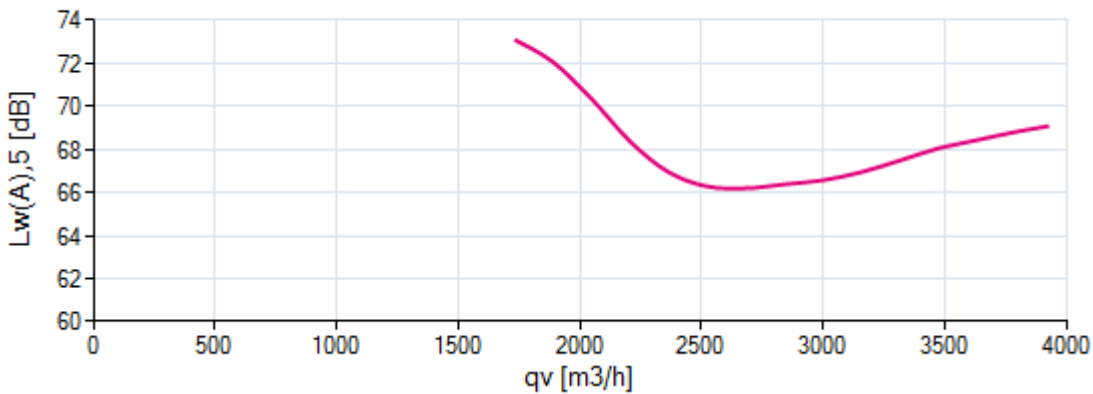

Power input

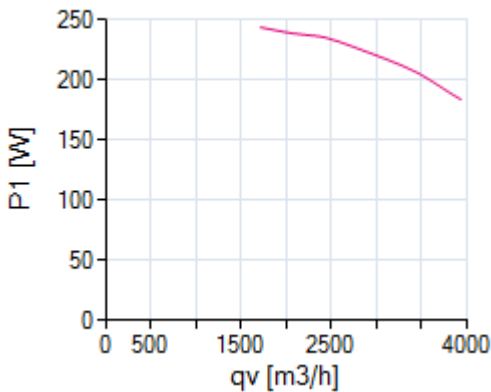

Efficiency

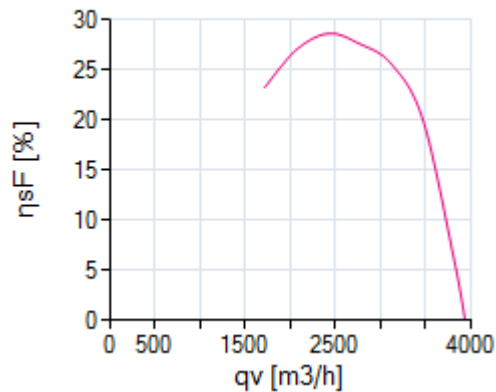

89302

Please note: It's not allowed to use this fan in the stall area!*

Article number
154201

The Royal League

Die Königsklasse

*In doubt please ask your responsible ZIEHL-ABEGG sales contact.

Data of operating point

frequency (f_{BP})	50	Hz
mains supply	1~ 230V 50Hz	
guard grille	no	

3. Drawing

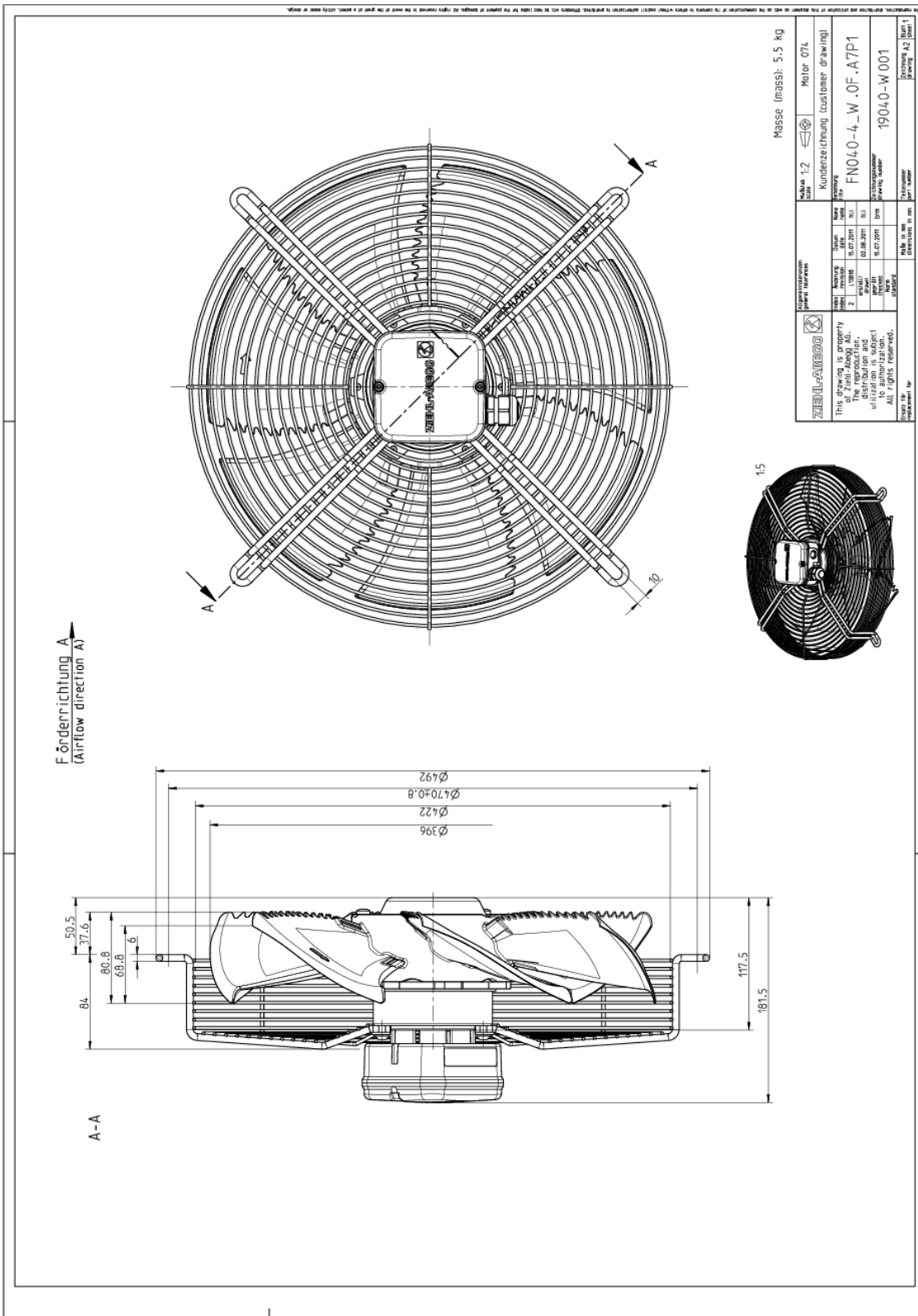

Dimensions in mm
Shown drawing is just to show the dimensions of the fan.

4. Connection diagram

1360-104XB

1~Motor with capacitor and thermostatic switch (if built in).

BN brown
BU blue
BK black
OG orange
WH white
GNYE green-yellow

Counter Clockwise rotation

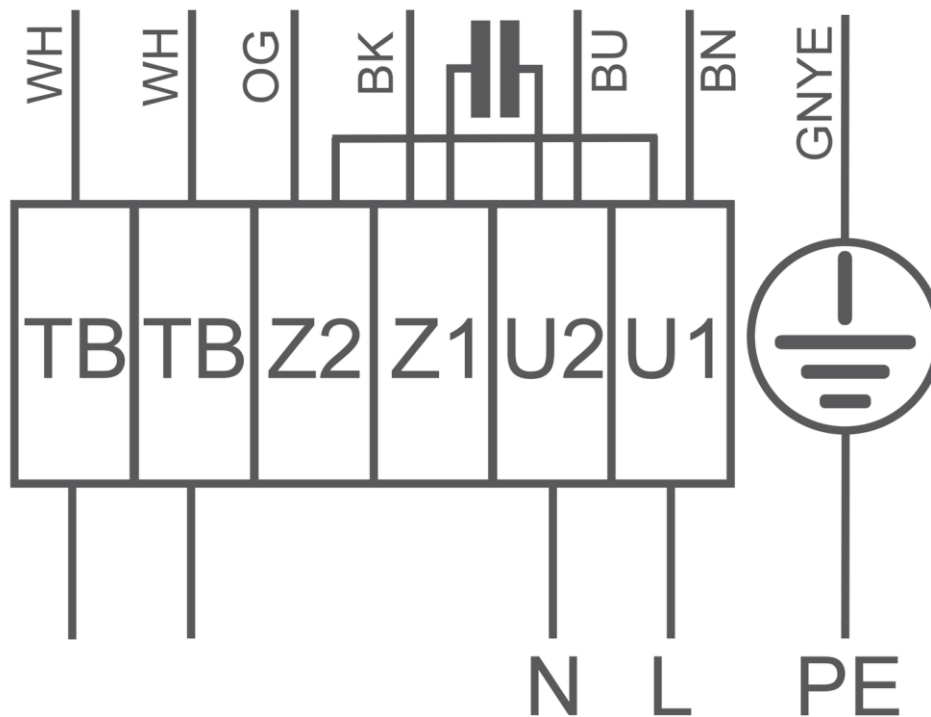

5. EU-Declaration of conformity

EU declaration of conformity

- Translation -
(english)

ZA75-GB 1910 Index 015

Manufacturer: ZIEHL-ABEGG SE
Heinz-Ziehl-Straße
74653 Künzelsau
Germany

The manufacturer is solely responsible for issuance of the declaration of conformity.

The products:

- External rotor motor MK..., MW..
- Axial fan DN..., FA..., FB..., FC..., FE..., FF..., FG..., FH..., FL..., FN..., FS..., FT..., FV..., VN..., VR..., ZC..., ZF..., ZG..., ZN..
- Centrifugal fan ER..., GR..., RA..., RD..., RE..., RF..., RG..., RH..., RK..., RM..., RR..., RZ..., WR..
- Cross-flow fan QG..., QK..., QR..., QT..

The motor type:

- Asynchronous internal or external rotor motor
- Asynchronous internal or external rotor motor with integrated frequency inverter
- Electronically commutated internal or external rotor motor
- Electronically commutated internal or external rotor motor with integrated EC controller

These products comply with the following EU directives:

- EMC Directive 2014/30/EU
- Low Voltage Directive 2014/35/EU
- ErP Directive 2009/125/EC, in conjunction with Regulation (EU) no. 327/2011

The following harmonised standards have been used:

EN 60034-1:2010 + Cor.:2010 EN 61000-6-3:2007 + A1:2011 + AC:2012
EN 60204-1:2006 + A1:2009 + AC:2010 EN 61000-6-2:2005 + AC:2005
EN 60529:1991 + A1:2000 + A2:2013

Compliance with the ErP Directive 2009/125/EC does not refer to external rotor motors MK..., MW..

All ErP-relevant information comprises measurements which are determined using a standardised measurement set-up. More details can be obtained from the manufacturer.

Compliance with the EMC Directive 2014/30/EU refers only to those products when they are connected by mounting / operating instructions. If these products are integrated into a system or supplemented with other components (e.g. sensing controls) and operated, the manufacturer or operator is responsible of the overall system for compliance with the EMC Directive 2014/30/EU.

Künzelsau, 05.03.2019
(location, date of issue)

ZIEHL-ABEGG SE
Dr. W. Angelis
Technical Director Air Movement Division
(name, function)



(Signature)

ZIEHL-ABEGG SE
Dr. D. Kappel
Deputy Head of Electrical Systems
(name, function)



(Signature)





The Royal League in ventilation, control and drive technology

Intelligent control technology for any application

ZIEHL-ABEGG system capabilities:
Everything from a single source – perfectly matched for optimal performance

Please contact us. We would be pleased to design an individual solution for your requirements.

We would like to welcome you on our worldwide exhibitions. Please find our next exhibitions [here](#).